

WAT-01U2 1/2.8" Compact Full HD USB2.0 Camera

Directly import the captured image to your PC and compact design specializes in the embedded application

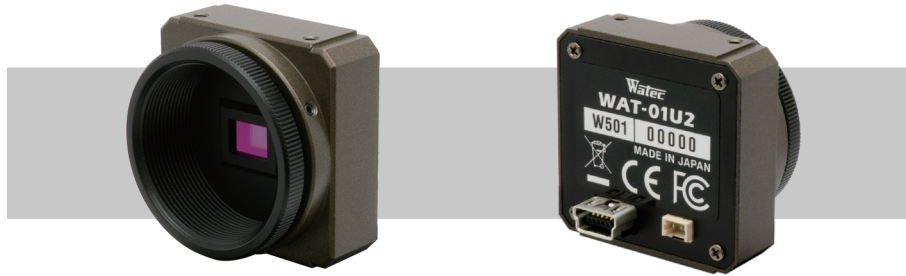

Key features

- Compact design (32 x 32mm) with CS lens mount and light weight
- 1/2.8-inch megapixel CMOS image sensor achieves the effective pixels 1984(H) × 1225(V)
- The internal ISP (Image Signal Processor) ensures optimal image quality depending on the usage environment
- USB Video Class & USB Bus Power (plug & play)
- Simple viewer software with features to change the camera settings and capture images.

Dimensions

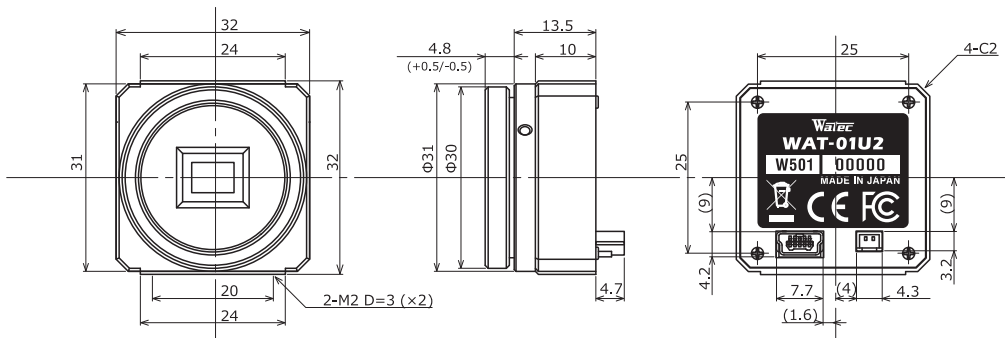

Specifications

Pick-up element	1/2.8 inch CMOS image sensor	
Number of effective pixels	1984(H) × 1225(V)	
Unit cell size	2.8µm(H) × 2.8µm(V)	
Imaging system	RGB primary color bayer arrangement mosaic filters on chip	
Synchronizing system	Internal	
Scanning system	Progressive	
Output size	1920×1080, 1280×1024, 1280×800, 1280×720, 640×480, 320×240, 176×144, 160×120	
Max. frame rate	30 fps	
Video compression	MJPG, YUY2	
Video output	USB Video Class (Compatible)	
Resolution (H)	More than 680TVL (Center)	
Minimum illumination	0.2 lx F1.2 (AGC ON=42dB, Shutter=OFF)	
	0.1 lx F1.2 (AGC ON=42dB, Shutter=1/15 sec.)	
S/N	-	
Function settings	Camera Viewer	
AE mode	Fixed	1/15 sec.
		1/30, 1/60, 1/120, 1/250, 1/500, 1/1000, 1/2000, 1/4000, 1/8000 sec.
	EI	1/30 - 1/8000 sec.
		1/15 - 1/8000 sec.
White balance	ATW, MWB	
AGC	ON	0 - 42dB
	OFF	-
MGC	0 - 24dB	
Gamma characteristics	γ=USER (Level adjustable)	
Noise reduction	-	
Wide dynamic range	-	
Lens iris	-	
Back light compensation	BLC	
White blemish correction	-	
Sharpness	Level adjustable	
Defog	-	
Digital zoom	-	
Privacy mask	-	
Mirror image	-	
Freeze	-	
Motion detection	-	
Neg.image	-	
Interface	USB (High speed), 2P connector (Snap shot)	
Power supply	USB +5V	
Power consumption	0.6W (120mA)	
Operating temperature	-10 - +50°C	
Storage temperature	-30 - +70°C	
Operating / Storage humidity	95% RH or less (Without condensation)	
Lens mount	CS mount (Back focus adjustable)	
Cable length	Shorter than 3.0m recommended	
Weight	Approx. 35g	
Accessories	Hex wrench, Camera bracket, EX cable, USB cable	
Min. System Requirements	CPU	800MHz or faster
	RAM	512MB or larger
	Others	USB2.0 Port
Recommended System Specifications	CPU	Intel® Core TM i Series
	RAM	2GB or larger
	Others	USB2.0 Port, 1920×1080 or better resolution display
Operation Confirmed OS	Windows XP 32bit/64bit (SP2, 3), Windows Vista 32bit/64bit, Windows 7 32bit/64bit, Windows 8 32bit/64bit, Windows 8.1 32bit/64bit, Windows 10 32bit/64bit	

Accessories Options

WAT-01U2

CS-mount lenses

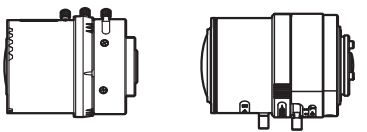

M13VM288IR A4Z2812CS-MPIR

Miniature lenses / Mount adaptors

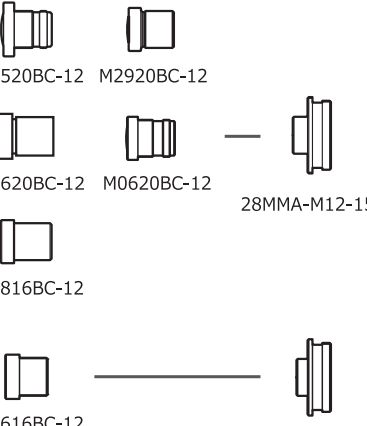

M2520BC-12 M2920BC-12
M3620BC-12 M0620BC-12 28MMA-M12-155
M0816BC-12
M1616BC-12 28MMA-M12-140

C-mount lenses

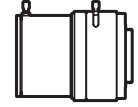

*Not in our lineup

C-mount adaptor



30CMA-R

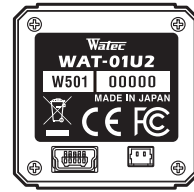
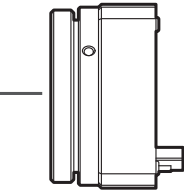

GPIO

Cable



EX cable (300mm) Snap shot

Cable

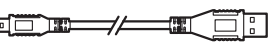

USB cable (1m)

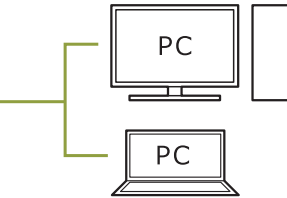

*Watec Camera Viewer recommended
Download from Watec website

Holder



H003

Camera bracket



B005

Stand



MS50